

SIRONIX

Healthium 

T-BUTTON R[®]

PEEK MENISCUS ROOT REPAIR IMPLANT

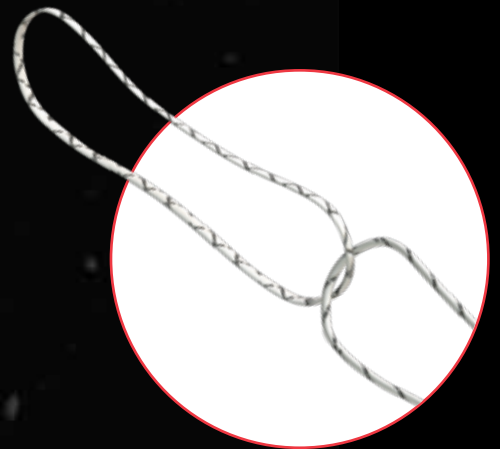

MAY THE SPORT OF LIFE NEVER STOP[®]

CINCH



Fiber Tape Loop

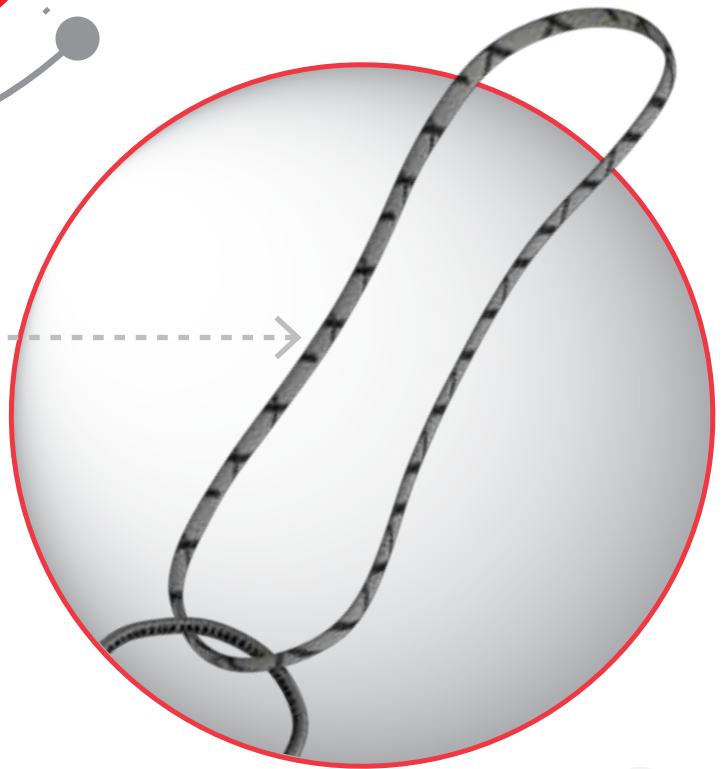

- **Fiber Tape construct:**
1.5mm width.
Provides larger surface area for a cinch knot.

SLIDE

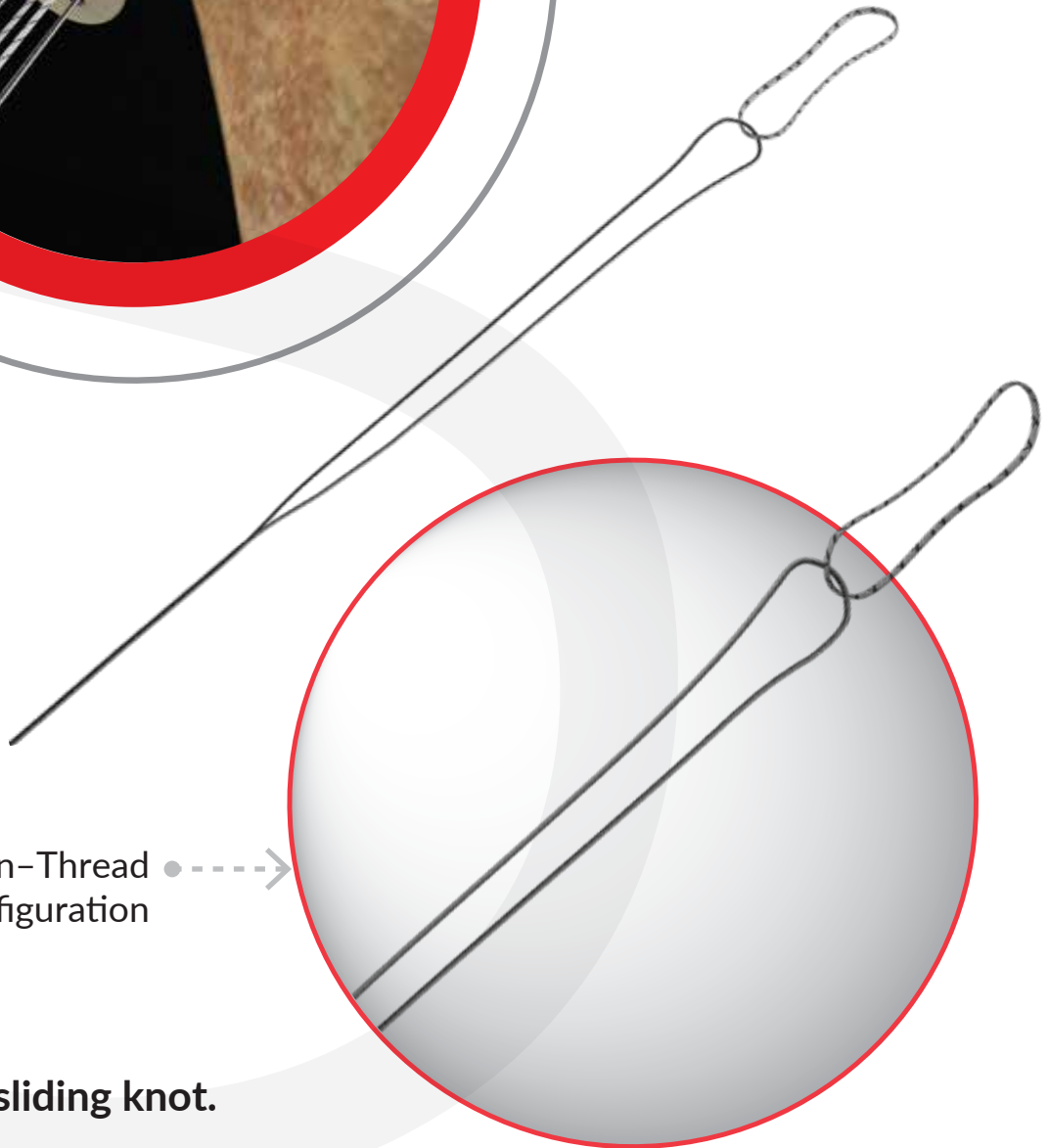
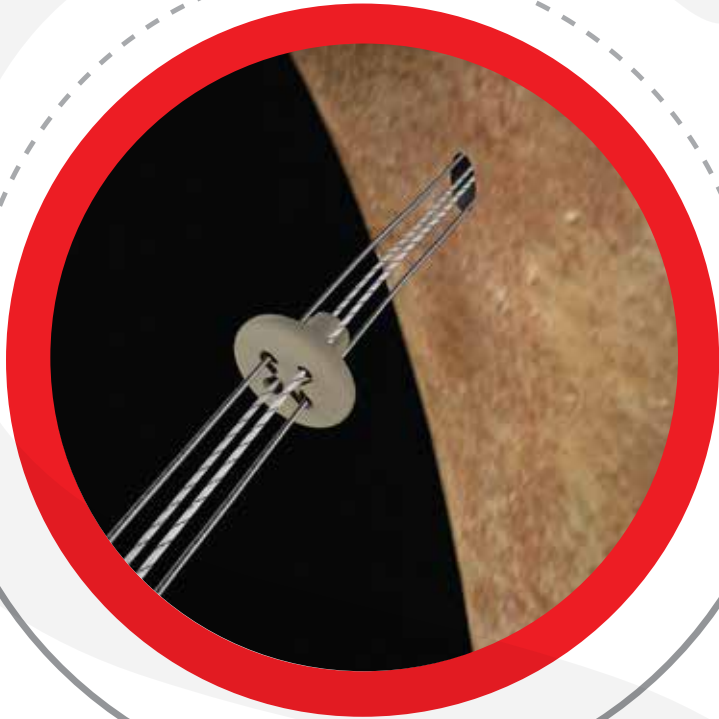

Thread-in-Thread configuration

- Secure with a sliding knot.
- Freedom to re-tension the fixation.
- 2 distinct colored loops for easy identification/differentiation during knotting.

TIE



- PEEK Construct of button offers Radiolucency.
- Stub provides additional stability.

T-BUTTON R DIMENSIONS

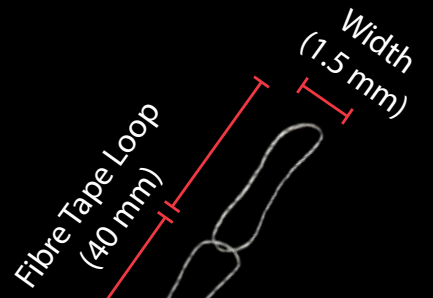
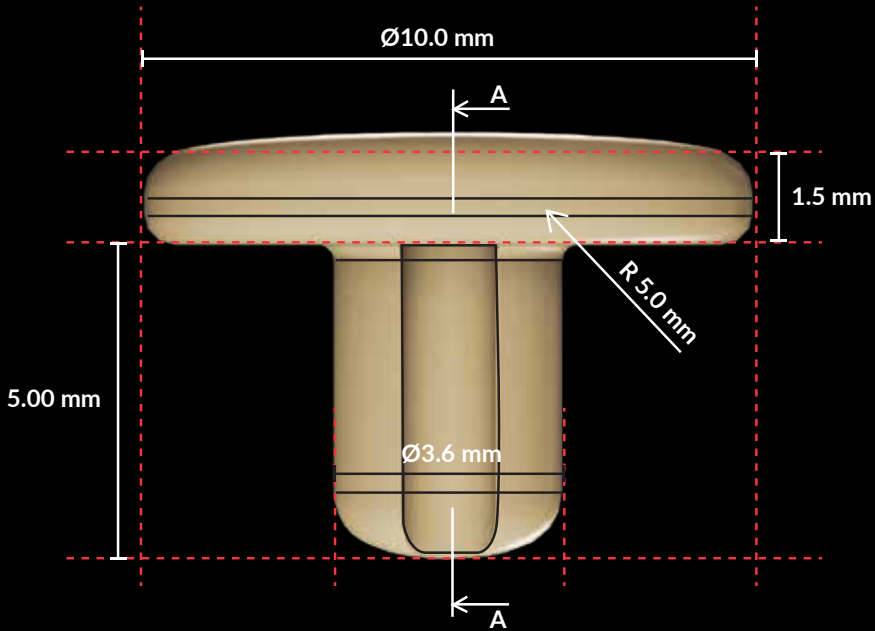

Tail (380 mm)



LOOP DIMENSIONS

Also available

T-Button®

ADJUSTABLE LOOP UHMWPE SUTURE PEEK BUTTON



T-Button A
(Closed)

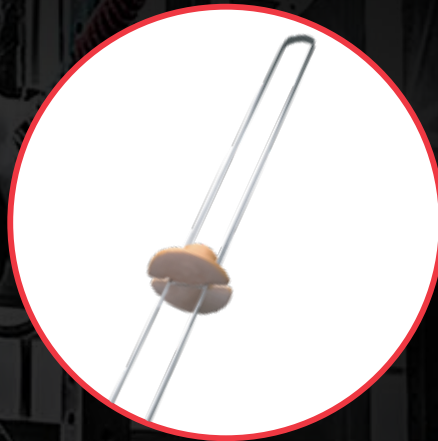

T-Button S
(Open)



Free Adjustable
Loop

USFDA
510(k) Cleared

Adequate pull-out strength*
Minimal MICRO motion*

Freedom to use thicker
grafts for solid fixation



To know more scan through your camera

Healthium Medtech Ltd.

RMZ North Star, Cowrks 12th Floor, Adjacent to RMZ Galleria Mall,
Yelahanka, Bangalore - 560 064, India
+(91)-(80)-4186 8198 | healthiummedtech.com

*Data on file

Application no: K231404